



Specification for **WS01 - WS07**

8" - 18" Adjustable centers

With Pop-up drain (not shown)

Inlets: 1/2" IPS

Max Deck Thickness: 1"

Spout Ring Diameter 27/8"

Spout Mount Shank 1" OD

Valve Body Diameter 1" OD

Valve-Spout Flex Connector

Length 9"

Connections 1/2" IPS

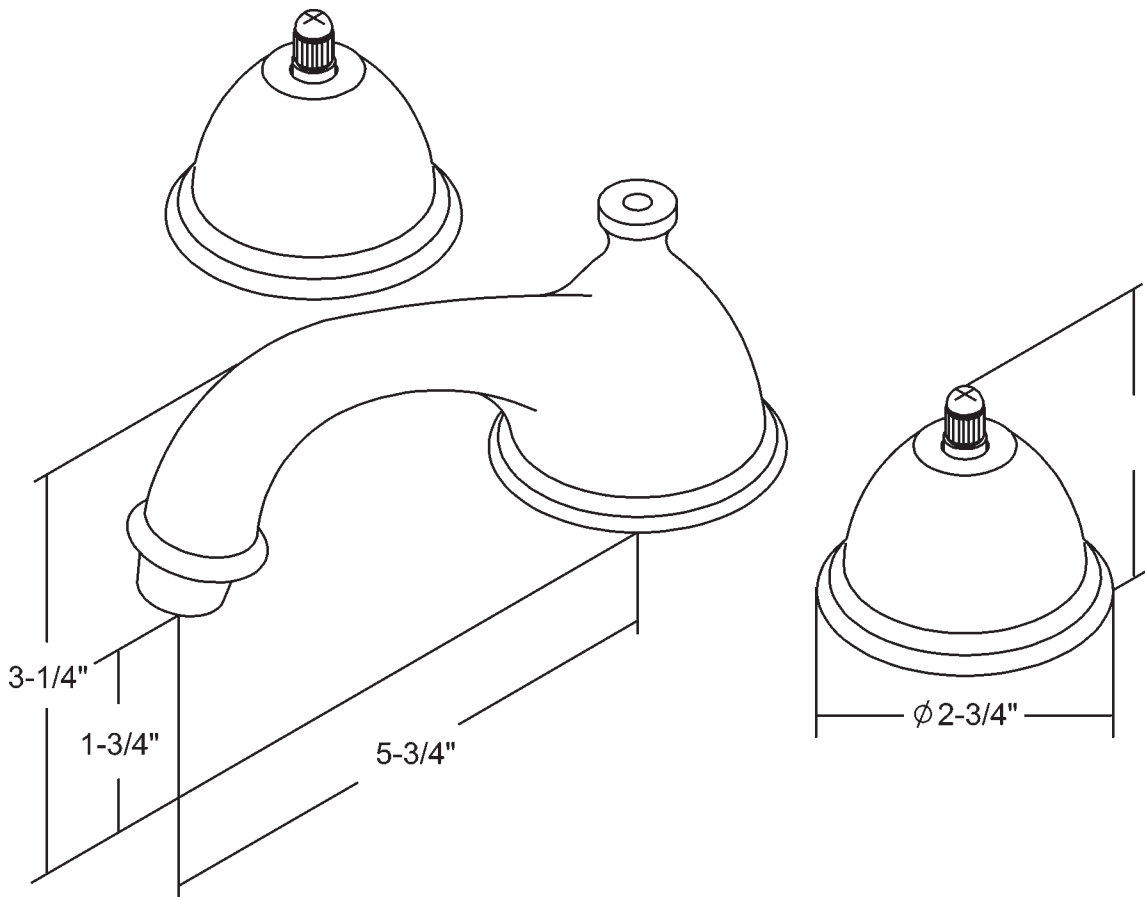

Revised 1/18/03